

TUBULAR ROLLING SHUTTERS P.120

Description

Built with tubes in electro-welded, galvanized steel, \varnothing 18mm, united together by vertical rods step 120mm. Vertical sliding and upper roll up.

Bottom slat height 485 mm, made of 3 blank slats + the bottom slat with handle and gasket stops.

On the top there are 2 or 3 blank slats for the roll up of the shaft.

It can be used as an insert for ventilation in blank shutters P.115.

Conform to UNI EN 13241-1 **CE**

The shutters exposed to the wind, for instance in case of façade installation, must have the Class 2 conforming with the EN 12424.

Characteristics and materials

Tube		\varnothing 18x1,0
Material		Galvanized steel
Weight	[kg/m ²]	8,00
Max Width	[m]	17,00
Places of use		Shops - Various

Dimensions

The values are approximates. For specific details contact our Technical Department.

In case of rotating shaft the minimum vertical space is 500 mm (motor + supports).

In the case of shutter with spring holder or octagonal shaft D.70 look at the following chart.

H Heigth	B – Roll Diameter mm																					
	Shaft with spring										Octagonal shaft D.70 with adapter D. 180											
5000	465	465	465	465	465	465	485	485	485	485	485	495	495	-	465	465	465	-	-	-	-	-
4500	450	450	450	450	450	450	470	470	470	470	470	470	470	490	450	450	450	450	-	-	-	-
4000	430	430	430	430	430	430	450	450	450	450	450	450	450	480	430	430	430	430	-	-	-	-
3500	410	410	410	410	410	410	430	430	430	430	430	430	430	430	410	410	410	410	410	-	-	-
3000	390	390	390	390	390	390	410	410	410	410	410	410	410	410	390	390	390	390	390	390	-	-
2500	370	370	370	370	370	370	390	390	390	390	390	390	390	390	370	370	370	370	370	370	-	-
2000	350	350	350	350	350	350	370	370	370	370	370	370	370	370	350	350	350	350	350	350	350	350
	1500	2000	2500	3000	3500	4000	4500	5000	5500	6000	6500	6750	7000	7500	1500	2000	2500	3000	3500	4000	4500	5000



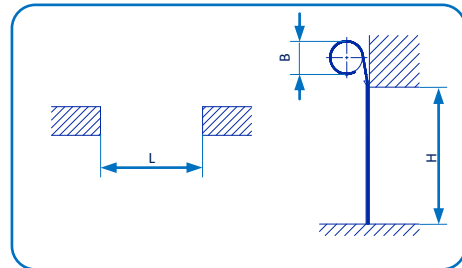
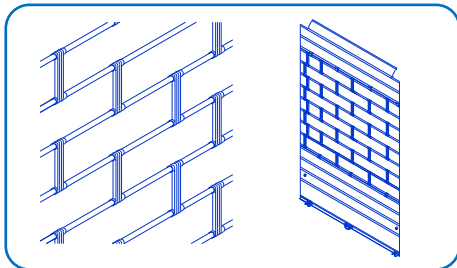

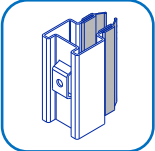
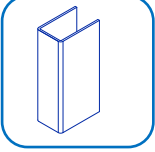
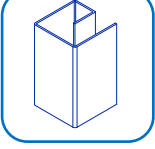

L – Length of the opening

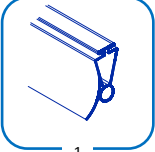
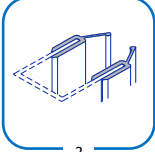
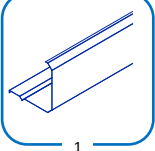
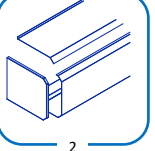
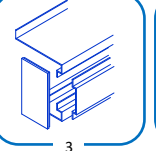
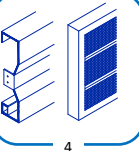

Guides

<p>Profiled guides in galvanized steel thickness 2,0 mm with gasket. For installation within and behind the opening</p>	
<p>U profiled guides in galvanized steel thickness 1,5 mm - 40 x 25 x 40 for widths until 4400 mm - 50 x 25 x 50 for widths until 5600 mm - 70 x 27 x 70 for widths until 7500 mm</p>	
<p>G profiled guides in galvanized steel thickness 2,0 mm - 60 x 60 – 80 x 60 – 80 x 80 – 100 x 80 - for shutters having a winding diameter higher than 450 mm - for installation behind the opening</p>	

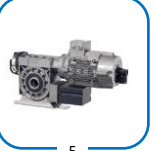
Accessories

Anti-noise system	
<ol style="list-style-type: none"> 1. Rubber Gasket applied to the bottom slat 2. Gasket in PVC 	 
Top and lid	
<ol style="list-style-type: none"> 1. Front panel 2. Carter composed by front panel, front upper and pair carter clips 3. Carter with removable front panel 4. External lid in galvanized sheet 	   
Automation	
<ol style="list-style-type: none"> 1. Manual operation for shaft with spring Round shaft \varnothing 48 – 60 – 76 – 89 – 101 2. Manual operation with torsional spring Octagonal shaft L. 70 – 102 3. Axial motor for shaft with spring Round shaft \varnothing 48 – 60 – 76 – 89 – 101 4. Tubular motor Octagonal shaft L. 70 5. Side motor Round shaft \varnothing 193 – 219 – 244 – 273 – 323 – 406 6. Forza motor Octagonal shaft L. 70 – 102 	     

Finish

Standard painting					
1000	Green beige	7004	Signal grey	8017	Chocolate brown
1001	Beige	7016	Anthracite grey	8019	Grey brown
1013	Oyster white	7021	Black grey	8024	Beige brown
1015	Light Ivory	7024	Graphite grey	9001	Cream
6005	Moss green	7040	Window grey	9002	Grey white
6009	Fir green	7046	Telegrey 2	9005	Jet black
6015	Black olive	7047	Telegrey 4	9010	Pure white
6019	Pastel green	8004	Copper brown	9011	Graphite black
6023	Mint green	8011	Nut brown	9016	Traffic white
7000	Squirrel grey	8014	Sepia brown		
7001	Silver grey	8016	Mahogany brown		

Special colours	
RAL 9006	Arsonisi Grey
RAL colours not included in Standard painting	Metallic black
White: Marble (smooth) – Ancient marble (rough)	Black / Brown: sandy (rough)
Grey: Marble (smooth) - Ancient marble (rough)	Sandy 900
Brown: Marble (smooth) – Ancient Marble (rough)	Gunmetal
Green: Marble (smooth) – Ancient Marble (rough)	Gold for external use
Red: Marble (smooth)	Hammered brown for external use

The complete range of rolling shutter

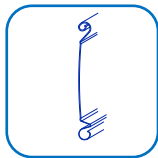

Blank P.115

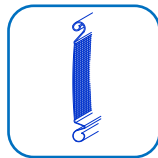

Micro-perforated P.115

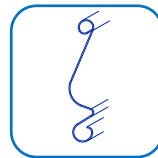

Blank P.97



Micro-perforated P.97

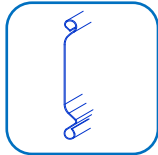

Blank P.73

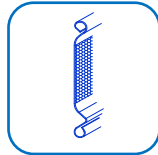

Micro-perforated P.73

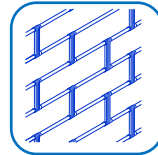

Tubular P.120

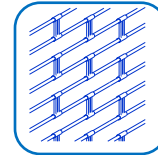

Tubular P.95

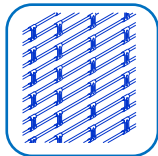

Tubular P.60

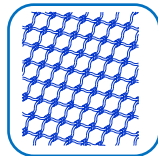

Tubonda

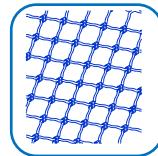

Tondino

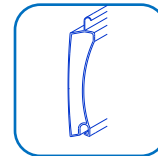

Insulated DP.77



Insulated DP.105

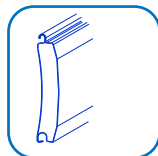

Insulated F.100

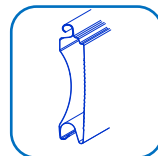

Insulated F.140

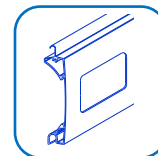

Windowed



Details and images in this leaflet are not binding.
Conegliano Serramenti s.r.l. reserve the right to modify them without notice at any time.

Conegliano Serramenti S.r.l

Via Campolongo 1/E Loc.Ramera Z.I. / 31010 Mareno di Piave – Treviso - Italy

Tel: +39 0438.4985 Fax: +39 0438.498540 / Web site: www.coneglianoserramenti.it www.forza-motion.com

P.I. e C.F.: 00532460268- N.Reg.Imp.di TV 8758 / Capitale Sociale i.v.: € 78.000,00 – Capitale esistente al 31.12.15 € 78.000,00i.v.